

COMPARATIVE STUDY BETWEEN PASSIVE AND ACTIVE FRONT-END INVERTERS WITH RESPECT TO INVERTER AND CABLE LOSSES

Desmet J. , Vanalme G., Howest Dep PIH Graaf Karel de Goedelaan KORTRIJK Belgium
Vandeveldel L., Ghent University, St.-Pietersnieuwstraat, GHENT Belgium
jan.desmet@howest.be

ABSTRACT

Nowadays, both active and passive front end rectifiers are used in modern inverter systems. Active front-ends, using high switching frequencies, create extra switching losses compared to passive front ends. However, using active front-ends, a power factor up to 1 and a negligible harmonic content of the loading current can be achieved, resulting in lower cable losses. This contribution analyses the weight of both inverter and cable losses with the aim to optimise all over power losses in a drive system.

KEY WORDS

power quality, cable losses, harmonics, inverter losses,

1. Introduction

The installation of variable speed drives in industrial plants is very common. The last decade the use of both common DC busses and active rectifiers are more and more used with the aim of rational use of electrical energy, using the four quadrant operation. Since passive rectifiers create high levels of the lower harmonics (up to the 19th harmonic) cable losses will increase due to the harmonic currents [5], [6], [7]. As a consequence, the use of active front ends will neutralise those harmonic currents. However, due to the active topology, switching losses will increase. In order to analyse the impact of both cable losses and inverter switching losses, a comparative study is performed.

2. Determination of Inverter Losses in Case of Passive Front Ends

The losses of a passive front-end are created in the rectifier diodes and consist of forward, switching and reverse losses.

During forward polarization the relation between diode voltage and current can be approximated by (1):

$$u_D(t) = U_D + R_D \cdot i_D(t) \quad (1)$$

where $u_D(t)$ is the instantaneous diode voltage drop, U_D the threshold voltage of the diode, R_D the dynamic resistance of the diode and $i_D(t)$ the instantaneous diode current.

The forward power losses are calculated by (2):

$$P_{D,forward} = \frac{1}{T} \int_0^T u_D(t) \cdot i_D(t) dt = U_D \cdot I_{D,avg} + R_D \cdot I_{D,rms}^2 \quad (2)$$

where $P_{D,forward}$ is the forward power loss of the diode, T the period of the net signals, $I_{D,avg}$ and $I_{D,rms}$ respectively the average and rms values of the diode current.

During switch off of the diode, a reverse current will build up the depletion layer. In a first approximation, it is assumed that during the switching period the reverse voltage increases and the reverse current decreases linearly. A graphic representation of the switching behavior is given in Figure 1.

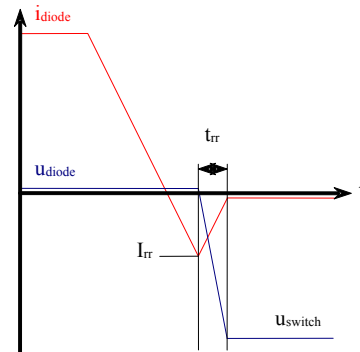

Figure 1: Switching of behavior of a diode

The switching power losses are calculated by (3):

$$P_{D,switch} = \frac{1}{T} \int_0^{t_{rr}} \frac{u_{switch} \cdot t}{t_{rr}} \cdot \frac{I_{rr} \cdot (t_{rr} - t)}{t_{rr}} dt = \frac{u_{switch} \cdot I_{rr} \cdot t_{rr}}{6T} \quad (3)$$

where u_{switch} and I_{rr} are respectively the diode voltage and inverse recovery current during switch off, and t_{rr} the recovery time.

During inverse polarization, a reverse current will flow due to the inverse voltage over the diode. The reverse power losses are calculated by (4):

$$P_{D,inv} = \frac{1}{T} \int_0^t u_{inv}(t) \cdot i_{inv}(t) dt = \frac{U_{inv,avg} \cdot I_{inv} \cdot t_{inv}}{T} \quad (4)$$

where $P_{D,inv}$ the reverse power losses, $u_{inv}(t)$ and $i_{inv}(t)$ respectively the instantaneous voltage and current during inverse polarization, $U_{inv,avg}$ and I_{inv} the average voltage and current during inverse polarization, and t_{inv} the duration of the inversed polarization.

The forward or conducting losses are the major losses in the diode, because of the significant voltage drop (ca. 2V) over the rectifier diodes and the current, which is determined by the load conditions, and the influence of the joule losses in the dynamic resistance during conduction. Switching losses occur only during the recovery time (order 10^{-7} s), 4 times each period for each diode. Since at that moment both voltage and current are noticeably decreased, switching losses are almost negligible compared to the conducting losses. Also the reverse leak current is very small with respect to the forward current. As a consequence, reverse losses are small with respect to the conducting losses.

3. Determination of Inverter Losses in Case of Active Front Ends

The losses of an active front-end are created in the IGBT's and the free-wheeling diodes [1], [2]. The PWM (pulse width modulated) signal is built up by both, the modulating signal (sinus) and a carrying wave, mostly a saw tooth function (Figure 2). The frequency of the carrying wave is the switching frequency of the PWM signal.

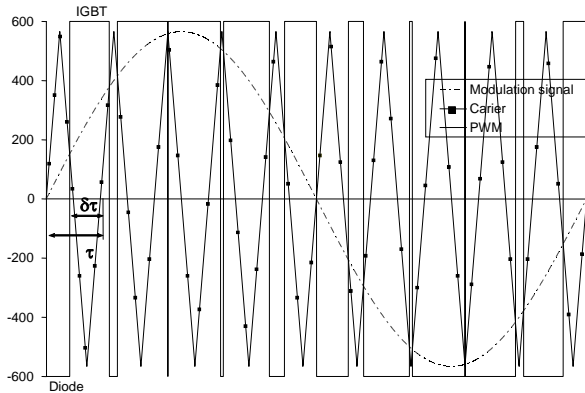

Figure 2: Modulation of a PWM signal

The duty cycle δ of the pulse with modulated signal can be written as:

$$\delta = \frac{1}{2} [1 + M \cdot F(t + \theta)] \quad (5)$$

where $F(t)$ is the modulation function, θ the phase angle between voltage and current and M the modulation index ($0 \leq M \leq 1$). Since the IGBT only conducts when the instantaneous value of the sine wave is greater than the saw tooth signal, the current flows through the IGBT only during one half period of the sine wave during a time $\delta \cdot \tau$, with τ the carrier period. In the time $(1-\delta) \cdot \tau$ of this half period the current flows through the opposite diode. During the other half period the IGBT is off and the current flows through the parallel diode. As a consequence, conducting losses in a IGBT and its free-

wheel diode will only occur during half a period of grid frequency. The conducting losses of a IGBT during a carrier period can be expressed as [2]:

$$E_{s,IGBT} = (U_{IGBT} + R_{IGBT} \cdot i_{IGBT}) i_{IGBT} \cdot \frac{1}{2} (1 + M \cdot F(t + \theta)) \tau \quad (6)$$

where U_{IGBT} , I_{IGBT} and R_{IGBT} are respectively the voltage drop, the current and the drain source resistance during conduction of the IGBT. In case the modulation signal is a sine wave function (7), the load current can be approximated by a sine wave.

$$F(t + \theta) = \sin(\omega t + \theta) \quad (7)$$

Integrating the energy losses (6) for one modulation period over half a period of the grid frequency, taking into account both the proposed current profile and modulation function, the conducting power losses in a IGBT can be calculated using (8) [2].

$$P_{s,IGBT} = \left(\frac{1}{8} + \frac{M}{3\pi} \right) R_{IGBT} I_{IGBT,max}^2 + \left(\frac{1}{2\pi} + \frac{M}{8} \cdot \cos(\theta) \right) U_{IGBT} I_{IGBT,max} \quad (8)$$

where $I_{IGBT,max}$ is the amplitude of the fundamental current. Analogously, conducting power losses in the freewheeling diodes can be calculated by changing the conducting time $\delta \cdot \tau$ in (8) by the conducting time of the freewheeling diodes $(1-\delta) \cdot \tau$:

$$P_{s,D} = \left(\frac{1}{8} - \frac{M}{3\pi} \right) R_D I_{IGBT,max}^2 + \left(\frac{1}{2\pi} - \frac{M}{8} \cdot \cos(\theta) \right) U_D I_{IGBT,max} \quad (9)$$

Losses in IGBT's caused by switching behavior can be derived from both voltage and current variations over the IGBT and freewheeling diodes as given in Figure 3. At the moment of transient conducting behavior of the IGBT, current in freewheeling diode will decrease to zero and consequently, IGBT current will increase up to load current. (1-2 in Figure 3). During this time interval, diode is still forward polarized and a small voltage drop over the diode will remain. As a consequence, almost the full inter-stage voltage will found back over drain source of the IGBT. Energy dissipated in the IGBT during transient conducting period (inrush) will be function of the rise time of the considered IGBT.

$$E_{IGBT,inrush} = \int_0^{t_r} U_{DC} \cdot \frac{i_{IGBT} t}{t_r} dt = \frac{1}{2} U_{DC} \cdot i_{IGBT,peak} \cdot t_r \quad (10)$$

where i_{IGBT} is the instantaneous current during inrush, U_{DC} the inter-stage voltage and t_r the recovery time.

The increase of current during the in conduction transient period is relatively constant. As a consequence, the current rise time is approximately proportional with the current due to the relative high drain source resistance of the IGBT with respect to the inductance of the firing circuit of the IGBT.

$$t_r = t_{rnom} \cdot \frac{I_{IGBTmax}}{I_{IGBTnom}} \quad (11)$$

where $I_{IGBT, nom}$ is the rated load current.

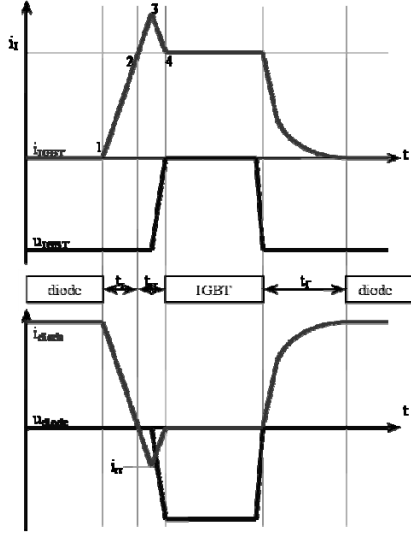

Figure 3: Switching wave forms of both IGBT and freewheeling diode

The averaged losses due to inrush during one period can be found by integrating (11) over one period. Taking into account a sine wave input current and a given switching frequency f_s , the total power losses during inrush can be written as:

$$P_{IGBT_{inrush}} = \frac{1}{8} U_{DC} t_r \cdot \frac{I_{IGBTmax}^2}{I_{IGBTnom}} \cdot f_s \quad (12)$$

During the switch off transient of the IGBT, the freewheeling diode will take over load current of the circuit. As a consequence, the voltage over the diode only exists of an voltage drop and inter-stage voltage will occur over drain source of the IGBT and conduction current will decrease until full blocking up of the IGBT. The energy losses during this transient time can be written as given in (13).

$$E_{IGBT_{switch\ off}} = \int_0^{t_f} U_{DC} \cdot \frac{i_{IGBT} \cdot (t_f - t)}{t_f} dt = \frac{1}{2} U_{DC} \cdot i_{IGBT} \cdot t_f \quad (13)$$

where t_f is the recovery time.

The decrease of the drain source current is initial very fast and approximately linear. Once the current reaches a low value, the decrease of current to zero will be exponential. As a consequence, the switch off time is not proportional any more with the increasing current through the IGBT. This decrease can be written as given in (14) [2].

$$t_f = t_{fnom} \cdot \left(\frac{2}{3} + \frac{1}{3} \frac{i_{IGBT}}{I_{IGBTnom}} \right) \quad (14)$$

Analogues as calculated for the inrush losses, the averaged switch off losses also can be calculated by

integrating (13) over one period. As a consequence, the total switch off losses will be found by multiplying the averaged losses by the switching frequency.

$$P_{IGBT_{switchoff}} = U_{DC} \cdot I_{IGBTmax} \cdot t_{fnom} \cdot \left(\frac{1}{3\pi} + \frac{1}{24} \cdot \frac{I_{IGBT}}{I_{IGBTnom}} \right) \cdot f_s \quad (15)$$

During the interval 2-4 (Figure 3), recovery losses will be found and the drain source current will increase to a value higher than the load current. The origin of this higher current has to be found in the discharge of the energy in the diode, in order to build up the blocking layer. On time step 3, all charges in the diode blocking layer are disappeared. On time step 4 the blocking layer is completely build up and no reverse diode current can exist, so the IGBT fully conducts. The losses in interval 2-3 are situated in the IGBT. The IGBT conducting current is the sum of both loading current and reverse recovery current of the diode, during recovery.

$$i_{2-3} = i_{IGBT} + i_{rr} \cdot \frac{t}{t_{rr}} \quad (16)$$

Consequently, energy losses can be written as:

$$E_{IGBT_{recovery}} = \int_0^{t_a} U_{DC} \cdot \left(i_{IGBT} + i_{rr} \cdot \frac{t}{t_a} \right) dt = U_{DC} \cdot i_{IGBT} \cdot t_{rr} + \frac{U_{DC} \cdot i_{rr} \cdot t_{rr}}{2} \quad (17)$$

During time step 3 – 4, losses will occur in both diode and IGBT. Since during this time step a reverse voltage exists over the freewheeling diode, reverse current will decrease to zero. On the other hand, voltage over the IGBT will decrease, while current also decreases to the load current value. So, energy losses in both freewheeling diode and IGBT are given by:

$$E_{D_{recovery}} = \int_{t_3}^{t_4} U_{DC} \cdot \frac{t}{t_{34}} \cdot \left(i_{rr} \cdot \frac{(t_{34} - t)}{t_{34}} \right) dt = U_{DC} \cdot \frac{i_{rr}}{6} \cdot t_{34} \quad (18)$$

$$E_{IGBT_{recovery}} = \int_{t_3}^{t_4} U_{DC} \cdot \frac{(t_{34} - t)}{t_{34}} \cdot \left(i_{IGBT} + i_{rr} \cdot \frac{(t_{34} - t)}{t_{34}} \right) dt = U_{DC} \cdot \left(\frac{i_{IGBT}}{2} + \frac{i_{rr}}{3} \right) t_{34} \quad (19)$$

In case of sine wave loading conditions of the active front end and using [2], the Total recovery losses will be found by integrating (18) and (19) over one full period.

$$P_{recovery} = f_s U_{DC} \cdot \left[\left(0,28 + \frac{0,38}{\pi} \cdot \frac{I_{IGBTmax}}{I_{IGBTnom}} + 0,015 \cdot \left(\frac{I_{IGBTmax}}{I_{IGBTnom}} \right)^2 \right) \cdot I_{rr} \cdot \frac{t_{rr}}{2} + \left(\frac{0,8}{\pi} + 0,05 \cdot \frac{I_{IGBTmax}}{I_{IGBTnom}} \right) \cdot I_{IGBTmax} \cdot t_{rrnom} \right] \quad (20)$$

4. Determination of Cable losses

The cable losses are determined by measurements. The practical test set-up is shown in Figure 4. The cable is loaded with both a standard drive with diode rectifier (passive front end) and a active front end drive, adjusted to PF=1. The inverter fed induction machine (IM) is connected to a DC-machine, controlled by a 4Q DC-drive

in order to obtain the same load conditions (same mechanical power) for different test set ups (different cable types).

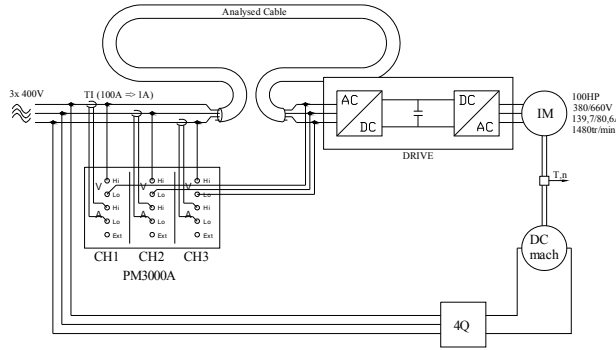

Figure 4: Schematic test set-up

The two tested drive loading conditions were at half load (42kVA) and at full load (84kVA) with respectively $60A_{rms}$ and $121A_{rms}$. A high-performance power analyzer is used to measure the power losses in the cable. This test set-up is also used to analyze the electrical behavior of the passive and active front-end drives and to determine the shaft power by torque and velocity measurements.

5. Quantification of the losses

5.1 Assumptions

Inverter losses are calculated using data obtained from measurements (Table 1) and data sheets (Table 2)

Table 1: Measured parameters during test set-up for passive (diode) and active (IGBT) front end

	Diode	IGBT
I_l	106,7A	102,9A
I_{rms}	122,6A	103,1A
CF	1,82	1,48
I_{peak}	223,13A	152,8A
I_{avg}	92,20A	92,47A
P_{shaft}	62,7kW	62,8kW

Table 2: Data of power electronic devices

Diode	IGBT				
	IGBT		Diode		
R_D	2,5m Ω	R_{IGBT}	8m Ω	R_D	6m Ω
U_D	2,05V	U_{IGBT}	2,1V	U_D	2V
t_{rr}	1890ns	t_r	125ns	E_{off}	8mJ
I_{inv}	15mA	t_f	620ns		

5.2 Losses in a three phase diode rectifier

The conducting losses of the 6 diodes of the three phase rectifier are calculated using (2), taking into account that the average and rms values of the phase current (Table 1) are twice the values of the diode current. The calculated value of 679,74 W is verified by simulations in Matlab, where a value of 679.76 W is found. The simulations were performed using the standard model of the system power toolbox, the data of Table 2 and the measured data of the load current.

In a three phase rectifier, each diode only is conducting during one third of a period, and consequently reversed polarized during two third of a period. The corresponding inverse voltage is determined by the instantaneous line voltage over envisaged and the corresponding phase, where the opposite diode is conducting.

The averaged voltage over the inverse polarized phase can be determined using (21). The total inverse losses is equal for each diode and appear once each period. Consequently, the total inverse losses are given by 6 times equation (3).

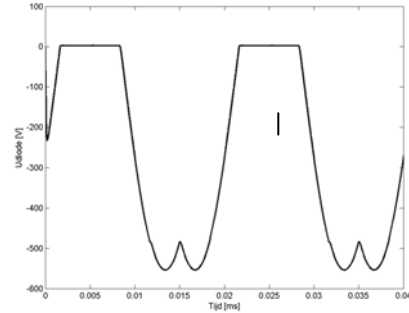

Figure 5: Inverse voltage over the reverse polarized diode

$$U_{gem\ inv} = \frac{3}{4\pi} \int_0^{4\pi/3} u_{diode} \cdot d\omega = 233,9IV \quad (21)$$

The switching losses are dependent of the reverse recovery current I_{rr} in the diode. This reverse recovery current is on its turn dependent of both loading current and the decreasing current slope. However, the maximum magnitude of that current never can be higher than the maximum loading current. In a first approach, the recovery current in (3) may be considered as equal to the peak value of the load current, which gives the highest possible switching losses. The value of the voltage u_{switch} is given by the instantaneous value of the voltage at 30° .

Table 3: Overview of the losses in a three phase diode rectifier

	Power losses [W]	Contribution [%]
Conducting losses	679,74	97,14
Inverse losses	14,04	2,01
Switching losses	5,96	0,85
Total losses	699,74	100,0

The calculated power losses in a three phase diode rectifier, as given in Table 3 indicates that the contribution of the switching losses are negligible with respect to the other losses. Since those values are the result of a worst case calculation, in practice it is shown that switching losses can be totally neglected. The contribution of the reverse losses are small with respect to the conduction losses.

5.3 Losses in an active front end

In case of an active front end, the conducting losses are determined by the losses in the IGBT and the freewheeling diodes, given by respectively (8) and (9). Since the conducting period is given by the modulation index M , conducting losses will be dependent of these value. Taking into account the magnitude of both the dynamic resistance of the IGBT (drain source resistance), and the corresponding threshold voltage (Table 2), the influence of the modulation index is rather low. Under normal operation conditions, the active front end is adjusted as such that the load current of the active front end is in phase with the line voltage. Since the basic topology of the active front end consists out of 6 IGBT's and 6 diodes, the equations (8) and (9) must be used in order to determinate conducting losses. As a consequence, total conducting losses will be the sum of both. The calculations yield 830,0 W. The calculated value is verified by simulations in Matlab, where a value of 825.45 W is found.

Since the switching losses are dependent of the used switching frequency (mostly 4Khz) and the applied line voltage (determined by the interstage voltage), equations (12) and (15) must be used in order to determinate the switching losses. The gathered values on his turn must be multiplied by six in order to become the total switching losses.

The recovery losses can be calculated using (20). However, the data sheets of an IGBT never mention the value of the recovery time of the IGBT, but only gives the value of the recovery losses in the freewheeling diode. As a consequence, the total recovery losses must be calculated using the recovery losses in the freewheeling diode, with respect to the switching frequency and the number of considered diodes during the half of period of the conducting diode. Those losses can be expressed using:

$$P_{recovery} = 6 \cdot \left(\frac{f_s}{2} \cdot E_{diode\ off} \right) = 96,9W \quad (22)$$

Table 4: Overview of the losses in a three phase active front end

	Power losses [W]	Contribution [%]
Conducting losses $P_{cond, Diode}$	74,0	6,3
Conducting losses $P_{cond, IGBT}$	756,0	65,9
Inrush losses	31,8	2,8
Switch off losses	190,4	16,6
Recovery losses	96,9	8,4
Total losses	1.148,1	100,0

In contrast with the three phase diode rectifier, the switching losses in the three phase active front end are not negligible at all. They amounts to 27,8% of total power losses of the three phase active front end. Furthermore, for a same active power, the total rectifier losses of the

inverter are 62% higher than in case of a passive three phase rectifier.

As mentioned, the value of the modulation index hardly has any influence on the total conducting losses. The explanation of this negligible influence can be found in the global dynamic resistance of the parallel IGBT and freewheeling diode. PWM pulses become more narrow with decreasing modulation index M . As a consequence, the time of the current in the freewheeling diodes increases. Since the dynamic resistance of the freewheeling diode is smaller in value than the dynamic resistance of the conducting IGBT, conducting losses will be smaller. For a change of the modulation index from $M = 1$ to $M = 0,7$, the difference in conducting losses hardly is 1%.

6. Analysis of the losses

Figure 6 shows the inverter losses as a function of the drive shaft power, both for inverters with active and passive front-end. The figure shows also the ratio of active to passive front-end inverter losses for the different load conditions. The inverter losses in case of active front-end are ca. 60% higher than in case of passive front-end for all load conditions.

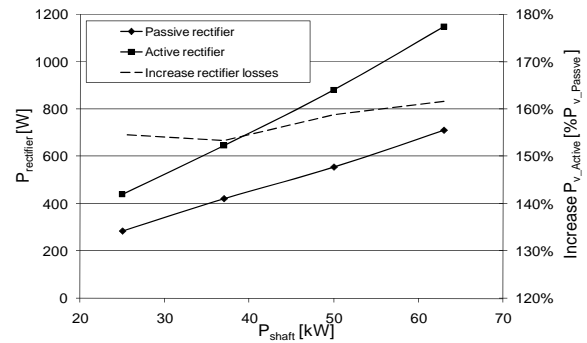

Figure 6: Inverter losses as a function of shaft power in case of active and passive front-end inverters

Fig. 7 shows the fundamental and rms joule losses per meter cable for different nonlinear load conditions (ac drives with passive front-end at different load conditions), compared with the joule losses in similar linear conditions (active front-end). The cable losses are approximately 40% higher in case of passive front-end than in case of active front-end (Fig. 9). For low loading conditions, the difference can increase up to 120%.

Figure 8 shows the total losses (sum of inverter and cable losses) as a function of cable length in case of active and passive-front end inverters. For a certain cable length, the total losses for active and passive front-end are equal. For shorter cables the losses for passive front-end are less, while for longer cables there are less losses for active front-ends. The break-even length of the cable increases with the cable section. Figure 11 shows for different load

conditions the break-even cable length. The shaft power has a minor influence on the break-even cable length.

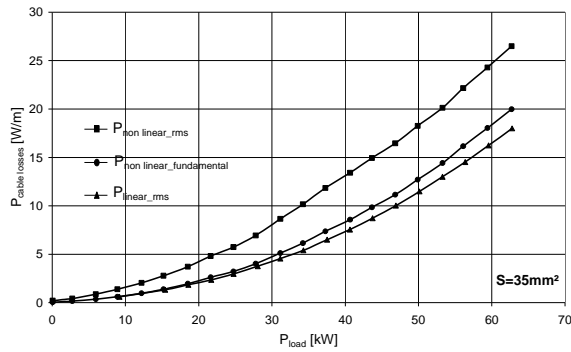

Figure 7: Fundamental and rms joule losses per meter cable in case of linear and non linear load conditions

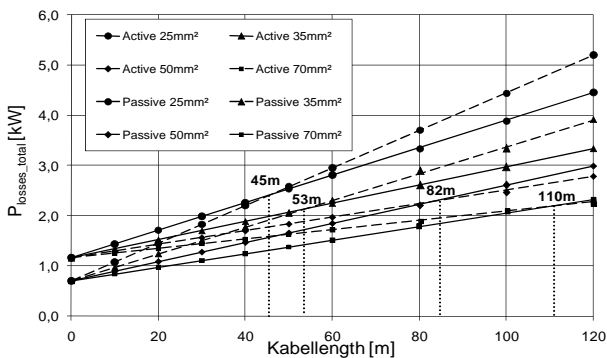

Figure 8: Total losses (sum of inverter and cable losses) as a function of cable length in case of active and passive front-end inverters@ 63kW

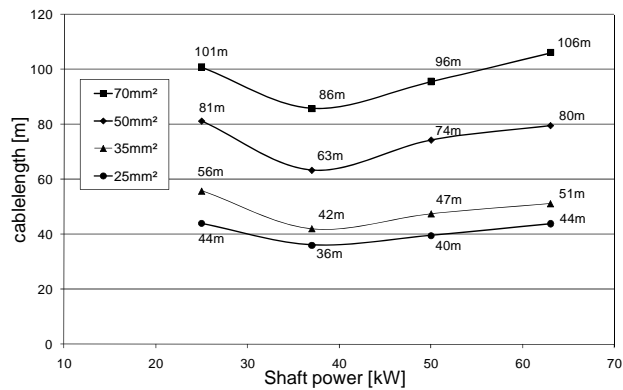

Figure 9: Break-even cable length as a function of shaft power

Besides higher cable losses, harmonic currents lead to higher transformer losses [3], [4] increasing the total losses in case of passive front-end. Active front-end inverters will be more energy efficient even at shorter cable lengths.

7. Conclusion

Rectifier losses for both active and passive front end were measured and calculated for different load conditions. In case of active front ends, the rectifier losses are always

higher than in case of a passive front end and amount up to 60% higher, nearly independent of load conditions.

It is also shown that cable losses in case of non linear load conditions (typical for passive front ends) are approximately 40% higher than cable losses in case of a sine wave current for same load conditions of the rectifiers [8]. As a consequence, from a certain cable length, cable losses always will be less in case of an active front end with respect to a passive front end.

This also means that there is an optimal cable length where the sum of cable and rectifier losses will be the same. For higher cable lengths, an active front end always will be energetic more favorable. This length is function of both cable cross section and load conditions of the inverter.

References

- [1] Alex Q. Huang, Bo Zhang; "Comparing SiC Switching Power Devices: MOSFET, NPN Transistor and GTO Thyristor", Elsevier Science Ltd; Solid State Electronics 44; pp. 325-340
- [2] F. Casanellas; "Losses in PWM Invertors Using IGBT's"; IEEE Proceedings Electronic Power Applications, Sep 1994, Vol. 141, No. 5
- [3] L. Ran, K. S. Smith, Y. Liao, G. A. Putrus; "Calculation of Transformer Core Losses with Nonlinear Loads"; IEEE transactions 2002, pp. 682-687
- [4] F. Tofoli, A. Morais, C. Gallo, S. Sanhueza, and A. de Oliveira, "Analysis of losses in cables and transformers under power quality related issues," in Proc. 2004 IEEE Applied Power Electronics Conference and Exposition, vol. 3, pp. 1521-1526.
- [5] J. Desmet, D. Putman, G. Vanalme, and R. Belmans, "Modelling and sensitivity analysis of the thermal behaviour of LV cables for different load conditions," International Conference on Harmonics and Quality of Power, Lake Placid, New York, USA, Sept. 12-15, 2004
- [6] J. Desmet, D. Putman, F. D'Hulster, and R. Belmans, "Thermal analysis of the influence of non linear, unbalanced and asymmetric loads on current conducting capacity of LV cables," in Proc. IEEE Power Tech Conf., Bologna, Italy, 23-26 June 2003.
- [7] J. Desmet, I. Sweertvaegher, G. Vanalme, and R. Belmans, "Total harmonic current of a large number of non-linear single phase loads," EPE-PEMC 2002, Cavtat & Dubrovnik, Croatia, September 2002
- [8] J. Desmet "Studie en analyse van de verliezen in laagspanningskabels onder harmonische belasting" Oct. 2008; ISBN 978-90-5682-962-9